



SOLAR-PLUS controller

Installation and Instruction Manual

- | | |
|--|----------|
| BIA-NXT-SOLAR-CONTROLLER | • 811832 |
| BIA-SOLAR PLUS CONTROLLER 50mm FLOW SENSOR | • 812139 |
| BIA-SOLAR PLUS CONTROLLER 40mm FLOW SENSOR | • 812140 |
| BIA-SOLAR PLUS PRO CONTROLLER 50mm FLOW SENSOR | • 812224 |
| BIA-SOLAR PLUS PRO CONTROLLER 40mm FLOW SENSOR | • 812225 |



i. Contents

i. Contents	2
ii. Glossary	2
iii. Introduction	3
iv. Symbols used in this manual.....	3
v. Before starting	4
SECTION ONE: SOLAR PLUS CONTROLLER	5
1a. Flow sensor.....	7
1b. 4-20mA pressure sensor.....	8
1c. RS485	8
1d. Generator Signal.....	9
1e. Controller Programming	9
1f. NXT SOLAR PLUS Parameters	10
1g. SOLAR PLUS PRO Control Panel.....	11
SECTION TWO: iSOLAR MOTOR.....	12
SECTION THREE: SOLAR PUMP INSTALLATION	14
3a. Electrical Connections.....	16
3b. Timer circuit	16
3b. Cable Jointing.....	17
3c. Installation Summary	18
SECTION FOUR: SOLAR ARRAY	19
4a. Solar array installation.....	20
SECTION FIVE: SYSTEM OPERATION	21
SECTION SIX: TROUBLE SHOOTING	24
6a. Trouble shooting chart.....	28
WARRANTY – Terms and Conditions.....	29

ii. Glossary

Term	Definition
Voc (V)	Volts - open circuit, nothing connected
Vmpp (V) or Vmp	Volts - maximum power point, under load
Isc (A)	Amps - short circuit
Impp (A) or Imp	Amps - maximum power point
DC Power in W	Vmp x Impp

iii. Introduction





Congratulations on your new BIANCO NXT SOLAR PLUS controller.

Developed in response to customer feedback, the SOLAR PLUS controller supersedes the iCon iSolarV3 controller. It is backwards compatible with any existing installation fitted with a M110, M240 or M22 motor (including PDP4).

DC power from a solar array fluctuates according to environmental conditions which can make it difficult to understand system behaviour. The NXT SOLAR PLUS provides a wealth of information regarding the system running state and offers more options than before to control and protect your pump.

This manual assumes that the controller is connected to an iSolar motor

iv. Symbols used in this manual

	Warning - Electrical safety
	Warning – Potential consequences of use outside of intended application(s). Includes environmental condition warnings.
	Mandatory warning
	Warning to disconnect power
	Read carefully

Reset to Factory Default settings











Turn off power to the control panel,

- Press and HOLD **START|STOP** as the power is turned on



When the display shows 099 release the **START|STOP** button.

v. Before starting

	<p>Please read the manual carefully and fully before starting.</p>
	<p>This appliance is not intended for use by persons (including children) with reduced physical, sensory or mental capabilities, or lack of experience and knowledge, unless they have been given supervision or instruction concerning use of the appliance by a person responsible for their safety. Children should be supervised to ensure that they do not play with the appliance.</p>
	<p>Any changes or modification to the wiring must be carried out by competent, skilled and suitably qualified personnel only.</p>
	<p>The pump is intended for pumping clean, sediment-free water. Performance and service life of the pump will be reduced in water containing a sand loading greater than 100gr/m³.</p>
	<p>Solar arrays are an attractive earth path for lightning strikes. Ensure the panels and controller are well earthed.</p>
	<p>Solar panels create electrical energy when exposed to light. Always treat solar panels as live and handle with care. Connected in series, the voltage increases for each additional panel up to the system maximum of 440Voc DC</p>
	<p>Never open the cover while controller is connected to an electrical supply. Disconnect and allow 2 minutes for the internal electronics to discharge before opening the cover.</p>
 	<p>iSolar motors have internal capacitors that MUST be allowed to discharge before handling. Allow 2 minutes for stored energy to dissipate before handling the pump/motor.</p>
	<p>The controller is IP65 rated but should not be exposed to direct sunlight. Install the controller where it has excellent ventilation away from direct sunlight or exposure to adverse weather.</p>

SECTION ONE: SOLAR PLUS CONTROLLER

An iSolar motor can operate connected directly to a suitable power source, either AC or DC. Connected directly, the motor is in a permanent run state and will endeavour to run whenever energy is available. The motor internal electronics provide some level of control and protection.

The SOLAR PLUS controller is designed, developed to provide real time information about the system operating state and to provide greater protection and control options than before.

The controller's primary function is to prevent the motor from starting excessively, especially when conditions are unsuitable.

The controller enables connection of external control devices such as floats or pressure switches to automatically maintain tank levels or stop the pump when no water is available.

When an alternative power source is available the controller can switch from AC to DC and back. Connected to a compatible auto-start generator, the controller will manage the generator operation automatically.



The SOLAR PLUS controller is weather-proof (IP65) and intended for outdoor use. Installation in direct sunlight, however, should be avoided.



A short press of START/STOP switches the unit between standby and active

Select the operating mode with short presses of the AUTO/MANUAL button

- DC MODE: power supplied from a Solar Array or Battery storage
- AC MODE: power supplied from a Generator or Mains power
- AUTO MODE: Automatic switching from DC to AC

The LCD screen provides considerable information about the current state of the system. The iSolar motor is always adjusting its operating state to make the best use of the energy available.

Displaying the operating state graphically enables the end user to better understand what is occurring and simplifies trouble shooting.

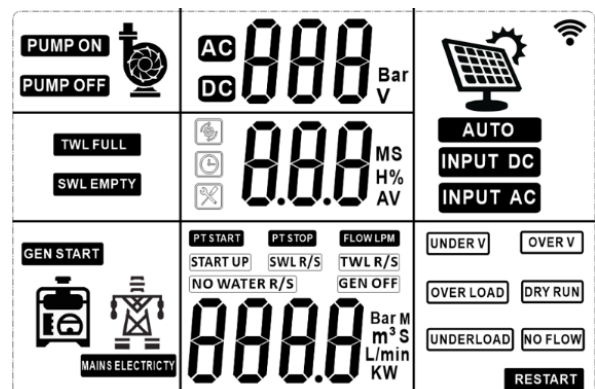

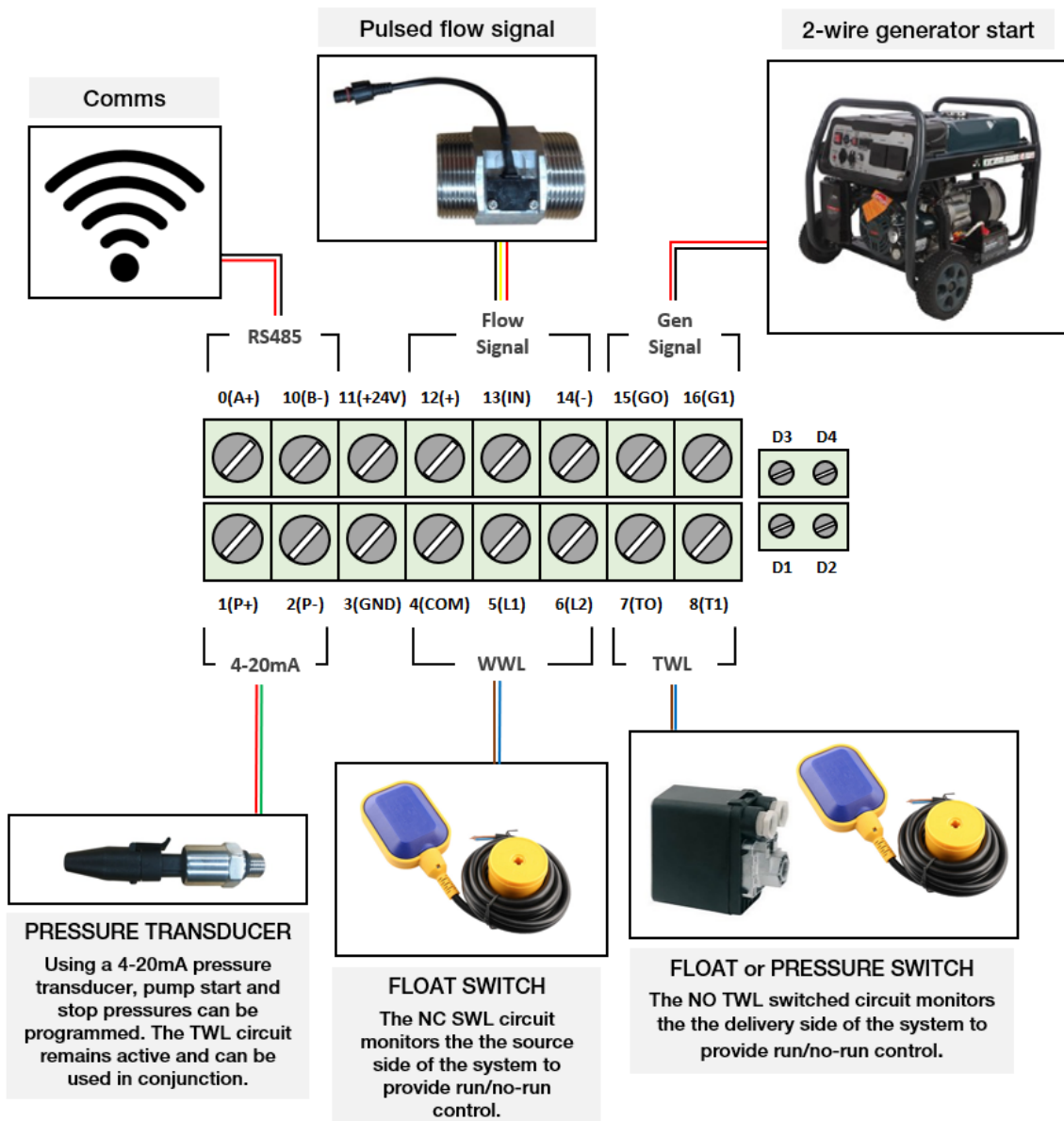

Terminals	Function	Programmable
SWL Input	Run/No run source control: Switched	Restart delay time
TWL Input	Run/No run source control: Switched	
4-20mA Input	Pump start / Stop Pressures	Start / Stop Pressures
Flow meter	Pulsed input: Shutdown at low flow	Restart delay time
Gen Signal	Signal to start an automatic generator in Auto Mode	Generator shutdown delay
RS485	Comms output: Modbus protocol	ID / Baud rate
D1, D2	Reserved / Inactive	~
D3, D4	Reserved / Inactive	~

1a. Flow sensor

A situation can arise when there is sufficient energy for the motor to start and exceed its internally pre-set minimum rpm, but the solar energy is not great enough that the pump can develop enough head to achieve flow. This results in a 'dead head' situation.

By fitting a flow sensor, the SOLAR PLUS controller is able to register whether water is flowing or not and will shut the pump down sooner than the internal programming.

Should the motor internal programming sense and interpret that the pump wet-end is running without water the motor will shut down in less than 3sec

Name	PN	Flow range
BIA-SSFLOWSENSOR-40 WITH CABLE	809521	40mm NB. 5 – 200lpm
BIA-SSFLOWSENSOR-50 WITH CABLE	809522	50mm NB. 10 – 300lpm

To enable the Flow sensor circuit, **set dip switch #3 in the upward position**

The Flow Sensor circuit works by sending a voltage from the controller to the flow sensor. The turbine wheel acts as a generator and returns a voltage proportional to the water velocity (flow), however its primary function is to send pulse signals to the controller.

Connect the flow sensor to terminals 12, 13, 14

If it is necessary to extend the cable, solder the joins for minimum resistance.

Flow sensor manufacturing batch variations may require the black and red wire positions to be reversed to ensure the controller can read the flow signal.

Blow GENTLY through the sensor to mimic flow and check it is reading before installing

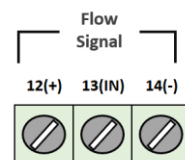
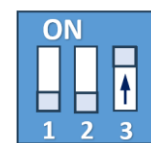

With the flow sensor circuit active, the user can view instantaneous flow and accumulated volume.



11	Minimum flow (pulses)	Range 0 – 254	Default 30
12	Trip Measurement period <i>Related to Parameter #11</i>	Range 0 – 254 sec	Default 180 sec Set to 250 sec
13	No flow restart attempts	Range 1 – 60	Default 05
14	Power on countdown timer	Range 1 – 254 sec	Default 120 sec Set to 45 sec

1b. 4-20mA pressure sensor

By setting dip switch position #2 in the upward position, the SOLAR PLUS controller will read a 4-20mA pressure transducer fitted to the discharge line.

Parameters 22 – 24 will need to be programmed

22	Pressure sensor range	Range 1 – 25.0	Default 25.0 bar	4 – 20mA
23	Stop pump setting	Range 1 – 25.0	Default 8.0 bar	
24	Start pump setting	Range 1 – 25.0	Default 2.0 bar	

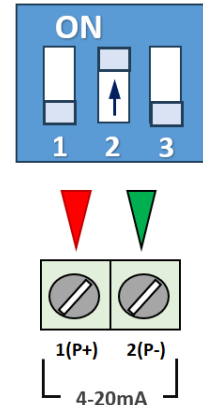

Ensure Parameter #24 is higher than Parameter #23

Name	PN	
BIA-TRANSDUCER 1MPA	802680	
BIA-TRANSDUCER 2.5 MPA	811954	
BIA-TRANSDUCER 2.5 MPA	811955	

'3 wire' pressure transducers have Positive (+), Negative (-) and Ground (Gnd) wires

Only Positive and Negative need connected to terminals 1 and 2.

4 – 20mA sensor do not follow set standards for colour.

Check carefully what the wiring colours represent on the sensor you are using.

1c. RS485

The NXT SOLAR PLUS has the ability to connect to an external monitoring device via the RS485 comms input. This provides the potential to remotely monitor, control AND to receive alarm notifications.



1d. Generator Signal

The NXT SOLAR PLUS controller can supply a START/SIGNAL to a generator with a 2-wire auto-start input.

With the controller in AUTO mode, the controller will prioritise DC energy. When that is insufficient, the controller will signal the generator to start and switch to AC input

- Default operation is DC. When the input voltage drops below the value programmed at Parameter 004 [default 45V] the AC input circuit is activated and signals the generator to start.
 - M110SOL set higher than 55V
 - M240SOL, set higher than 90V
- A programmable count down sequence will commence and the pump will start on AC.
- Once DC voltage rises above 55V/90V and current stabilises, the pump will shut down and immediately commence the 2min count down (assuming delay timer set to zero) before it switches back to DC power and continues running.

Parameter 010 provides a delay time for generator shutdown to prevent the generator turning on and off repeatedly.

1e. Controller Programming

To enter programming mode, the pump cannot be running

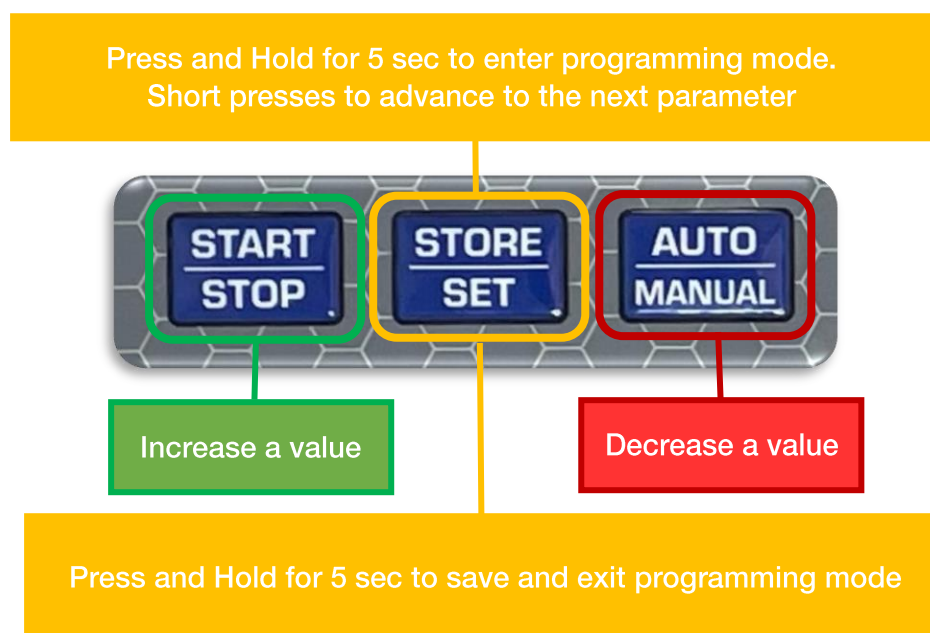

1f. NXT SOLAR PLUS Parameters

Parameter	Name	Details	
01	Controller ID	Range 1 – 17	Default 01
02	MODBUS Comms Baud Rate	01 = 1200bps 02 = 2400bps 03 = 4800bps 04 = 9600 bps (default)	
03	Parity Check	0 = None, 1 = Odd parity, 2 = even parity	

RS485 COMMS

04	Trip Voltage of DC to AC	Range 1 – 300	Default 45V
05	DC Over-voltage	Range 1 – 500	Default 280V
06	AC Under-voltage	Range 1 – 300	Default 150V
07	AC Over-voltage	Range 1 – 500	Default 290V
08	Pump overload current	Range 00 – 40.0	Default 25.0 amps
09	Generator/Mains (AC) settings	0 = Auxiliary Input Mains 1 = Auxiliary Input Generator	
10	Generator shutdown delay setting	Range 00 – 60 min	Default 03 min
11	Minimum flow (pulses)	Range 0 – 254	Default 30
12	Trip Measurement period <i>Related to Parameter #11</i>	Range 0 – 254 sec	Default 180 sec
13	No flow restart attempts	Range 1 – 60	Default 05
14	Power on countdown timer	Range 1 – 254 sec	Default 120 sec
Parameter 14 allows the iSolar motor capacitors to discharge prior to starting. Alter with care			
15	SWL restart delay timer	Range 0 – 60 min	Default 10 min
16	WWL restart delay timer	Range 0 – 60 min	Default 10 min
17	Under/Overvoltage recovery time	Range 0 – 60 min	Default 02 min
18	Overcurrent recovery time	Range 0 – 60 min	Default 02 min
19	Flow recovery restart time	Range 00 – 60 min	Default 30 min
20	No flow (pulse) restart time	Range 00 – 60 min	Default 60 min
21	Controller Button Lock	YES / NO	00 = Off 01 = On

22	Pressure sensor range	Range 1 – 25.0	Default 25.0 bar	4 – 20mA
23	Stop pump setting	Range 1 – 25.0	Default 8.0 bar	
24	Start pump setting	Range 1 – 25.0	Default 2.0 bar	

AC and DC compatible

AC voltage input range, Single phase: 90 – 280 VAC.
 DC voltage input range, 60 – 380 Vmpp/440Voc.

1g. SOLAR PLUS PRO Control Panel



Powder Coated Steel



SS-FLOWSENSOR50



Stainless Steel SS304

‘Plug-n-play*’ SOLAR PLUS PRO option in vented powder coated or stainless steel enclosure

- Fitted with AC and DC Circuit breakers and IP44 rated power connector for pump motor
- 240VAC power lead for mains supply
- MC4 input connections for solar array
- Weather-proof and suitable for outdoor installation

The Solar Control Pro Panel allows the system to be pre-wired off site.

** Site specific programming necessary*



SECTION TWO: iSOLAR MOTOR

The heart of the BiANCO NXT iSolar system is the unique motor design.

The iSolar M110, M220 and M240 are a truly innovative rare earth, permanent magnet motors.

Internally, the motor has a two-stage electronic frequency converter enabling it to be powered directly with either AC or DC power.



The internal electronics incorporate preprogrammed electronic motor management with MPPT and Vector Control logic to select the best operating point for the pump. The performance characteristic of a range of DAB hydraulic wet-ends are mapped into the EMM software enabling it to adjust motor output based on the input energy available.





NEVER perform insulation resistance checks using a megohmmeter as this can damage the internal motor electronics.

The iSolar EMM software provides the following functions:

- | | |
|--|--------------------------------|
| 1. Accepts AC or DC power | 8. Over-current protection |
| 2. MPPT (maximum power point tracking) | 9. Lost-Phase protection |
| 3. Vector control | 10. Missing-voltage protection |
| 4. Dry run protection | 11. Over-power protection |
| 5. Reverse protection | 12. Low voltage protection |
| 6. Over-head protection | 13. Stall protection |
| 7. Over-load protection | |

iSolar M110 / M220 / M240 Motor INPUT ENERGY Limitations

Power Source		Voltage	Current
	Direct Current i.e. Solar	60 – 380Vmp 60 - 440Voc	12A DC (Isc)
	Alternating Current i.e. Generator or Mains Supply	90 – 280V AC Single Phase	10A AC

Depending on the hydraulic load and the available power input, the motor speed will vary from 1500 to 3000 rpm to deliver water in the most efficient manner as determined by the internal EMM software.

When running, it is entirely normal for the power consumption to fluctuate constantly. The NXT SOLAR PLUS controller provides additional control and protection but, it is NOT responsible for the motor behaviour in operation.

Due to the internal magnetism of the motor the spline will not turn as freely as an asynchronous bore pump motor. The M240 has greater magnetic resistance to rotation than the M110.

As the spline is rotated the action will feel 'notchy' but not in a harsh mechanical sense.

Operating conditions:

- Water temperature has an impact on pump performance. Recommended water temperature of 20-30° C.
 - Maximum axial thrust 3000N.
 - The maximum immersion depth 150m.
 - A properly sized cooling sleeve is highly recommended in all installations and mandatory for power input over 1200W
-
- For best lifespan and reliability, **a vertical installation is preferred**
 - If installed horizontally, the motor end must NEVER angle upwards
 - Pump installation angles less than 15 degrees from horizontal are not recommended
 - The motor bleed hole must be in the upright position when installed



1	Electrical cable scuff protector
2	M4 screws
3	iSolar Motor
4	M8 nuts
5	M8 studs
6	Electrical cable
7	S4 Wet end

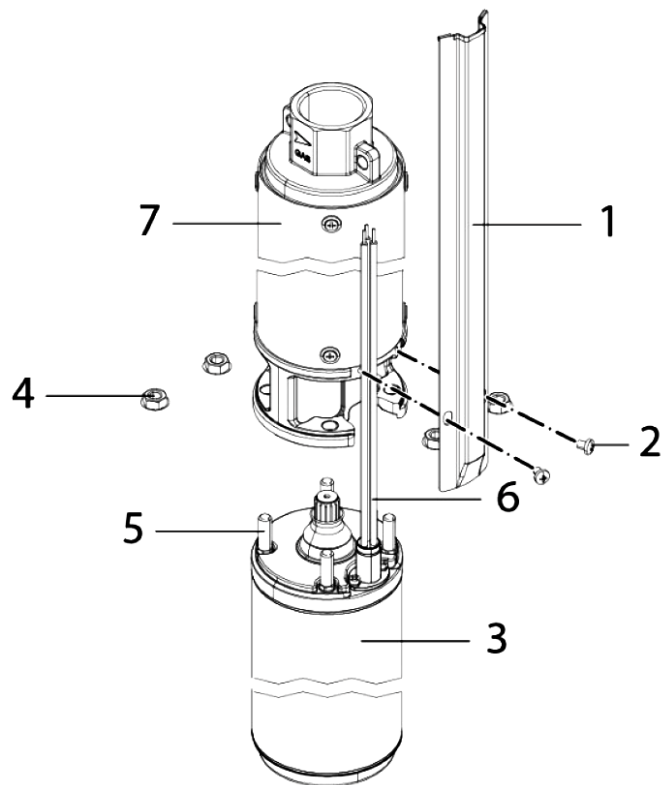

PUMP COOLING SHROUD

Estimated motor consumed wattage = total wattage of the solar array and less 30%.

Example: If the total size of the solar array is 3000W, less 30% = 2100W. At peak power, it is expected to be above 2kW, so fit a shroud.

A shroud is essential if the current drawn by the motor is above 2kW. The optimum cooling will be achieved by a water velocity of 80mm/sec past the motor.

SECTION THREE: SOLAR PUMP INSTALLATION

The hydraulic wet-end is the same as that used on a standard bore pump and the installer should follow 'best practice', treating it as any other bore pump installation.

White International shall not be held responsible for damage caused by improper installation, use of incorrect cable specifications, negligent or careless handling, lightning, improper voltage supply, corrosion due to impure water, wear caused by sand, gravel or other abrasives in the water being pumped.



The water source must be clean water free from contamination such as dirt, dust, loose rocks, decaying organic matter or any other foreign bodies that could block the intake.



Sand greater than 150gm/m^3 will accelerate wear and shorten the lifespan of the pump. Warranty does not cover failure or wear due to abrasives in the water.

GENERAL PRECAUTIONS

- Never support the weight of the pump by the power cable or delivery pipe. ALWAYS use a drop cable/safety rope attached to the wet end lifting eye.
- White International recommend fitting a low-level protection to ensure the pump switches off should the water level reach 150mm above the pump suction inlet.
- A check valve must be installed on the pump outlet or at the well head. Additional check valves for heads greater than 80 metres may be necessary. These will reduce water hammer shocks to the pump.
- For best lifespan and reliability, **a vertical installation is preferred**
- Pump installation angles less than 15 degrees from horizontal are not recommended.
- The motor bleed hole must be in the upright position when installed



In-tank installations

- The pump should be installed as upright as practical.
- A motor shroud (cooling sleeve) should be fitted
- Fit a non-return check valve to the top of the pump.
- Rigid piping is recommended to prevent the pump twisting.
- Include a flushing or scour valve on the base of tank to enable periodic cleaning of the tank bottom to minimise silt build-up.

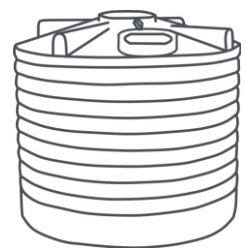

Borehole installations

- Damage to pump or motor caused by abrasive or corrosive water is not covered by the Warranty.

To prevent damage to the pump by aggressive water, an analysis of the bore water should be carried out prior to installation to ensure pump suitability.

Note: Sand content not to **exceed 150g/m³** of water pumped

- The bore must be clean before installation. Warranty does not cover failure or wear due to abrasives in the water.
- Know the total depth of the bore and ensure that the pump does not rest on the bottom or in sand. Ensure 1.5 metres clear below the pump to the bottom of the bore.

Know the pumping level (drawdown level) of the bore and ensure that the pump is always submerged. Minimum water level should always be 150mm above the pump inlet.

- Ideally the pump should be installed above the level at which water enters to bore to ensure water is drawn past the motor to provide adequate cooling

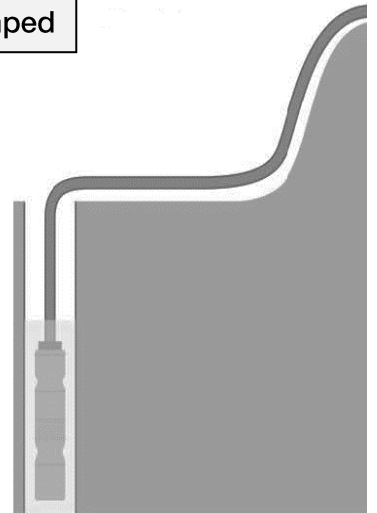

Pumping from an open body of water – Pond or Stream

- Vertical installation ensures best life expectancy
- Ensure the water is drawn constantly from below the water surface to minimise contamination.
- A simple, buoyant method of mounting the pump is to build a pontoon from PCV fittings.
- Regular inspections of the wet-end intake screen are recommended. Organic growths reducing the inflow to the wet-end will result in unusual motor behaviours

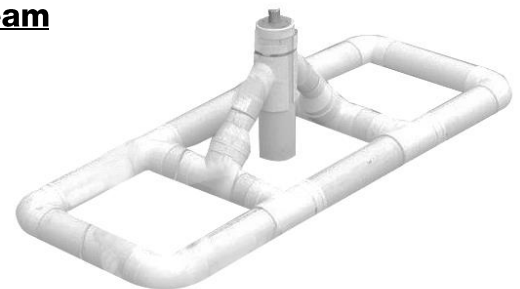

PRESSURE PIPE SELECTION

Some iSOLAR wet-ends pump can generate extremely high pressures. Select and use suitably pressure rated water delivery piping.



PRESSURE PIPE SIZING

System decisions when employing solar solutions favour maximum efficiency. Selecting pipe sizes to minimise frictional losses is encouraged.

LOW VOLTAGE, LOW-LEVEL FLOAT or PROBES

The pump motor has inbuilt 'dry-run' protection and will stop after 3 seconds if the wet end is running completely dry.

Fitting additional low-level protection, a minimum of 150mm above the pump inlet is recommended.

PUMP MOTOR EARTHING

The iSolar M220HR motor cable has an earth lead which **MUST** be connected to the Earth (ground circuit) of the V3 controller. If operating or testing the pump, ensure the motor is well earthed to prevent a lethal shock hazard



3a. Electrical Connections

Controller and DC input power isolator

- Install the controller where it is shielded from adverse weather and out of direct sunlight. Mounting in the lee of the array or inside an additional enclosure is recommended.
- Earth the controller body to ground.



Any electrical alterations or additional connections should be carried out by a suitably qualified technician.

Ensure the controller is isolated before removing the cover to access the low voltage circuit connections.

The controller is IP65 rated but should not be exposed to direct sunlight. Install the controller where it has excellent ventilation away from direct sunlight or exposure to adverse weather. Installation inside a separate open fronted enclosure is suggested.

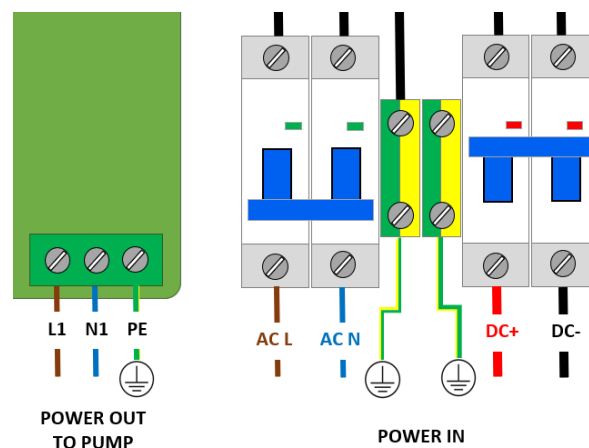
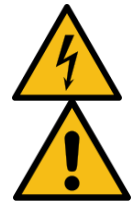

NEVER perform insulation resistance checks using a megohmmeter as this can damage the internal motor electronics.

3b. Timer circuit

Option not available at this time

3b. Cable Jointing

Jointing kit contents:

- 4 x Item Crimp Connectors (BP025)
- 4 x Item 10mm x 60mm HEAT SHRINK TUBE with RESIN
- 1 x Item 25mm x 305mm HEAT SHRINK TUBE with RESIN

To ensure a properly sealed joint, a Heat Gun capable of $\geq 275^{\circ}\text{C}$ is required to shrink the insulation sleeving (items 2 and 3).

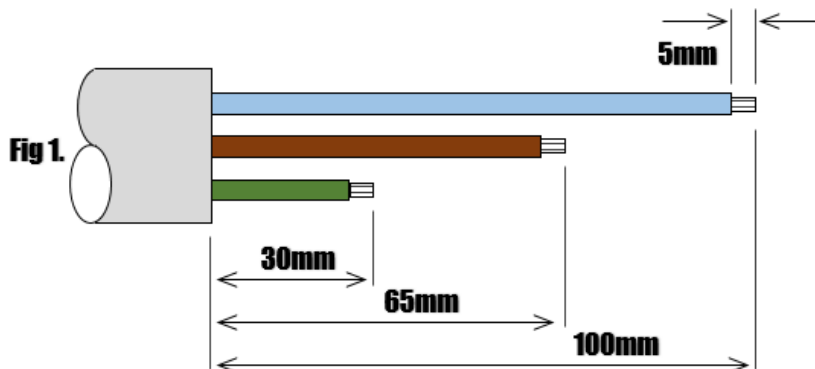

1. Remove 100mm of outer insulation from each cable to be joined, taking care not to damage secondary insulation.
2. Reduce the three wires of each cable to the dimensions shown in Fig.1, ensuring that the wire colours align as Fig.2.

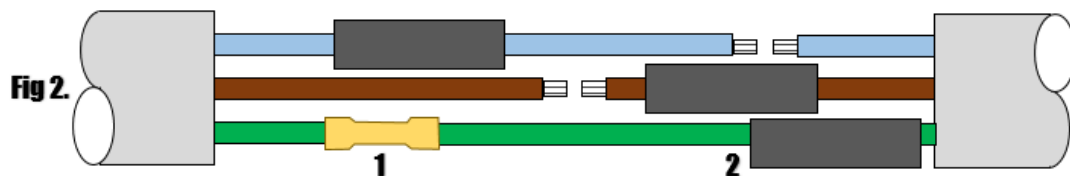

3. Slip item (3) over one end of the cable and item (2) over each of the three wires before using item (1) Crimp Connector to join wires as shown in Fig.2. Complete all crimps and locate item (2) over the completed crimps before commencing to heat shrink the individual connections.

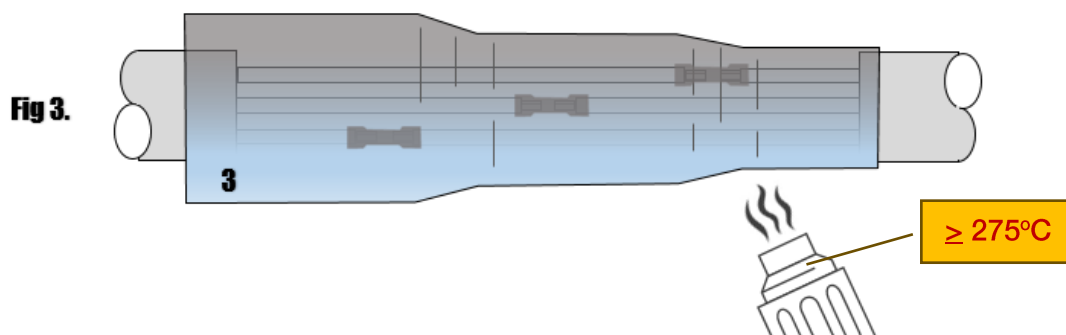

4. Locate item (3) centrally over the three wires and commence to shrink from one end as shown in Fig.3.
When sleeving is shrunk to its maximum, the cable joint is complete.

3c. Installation Summary

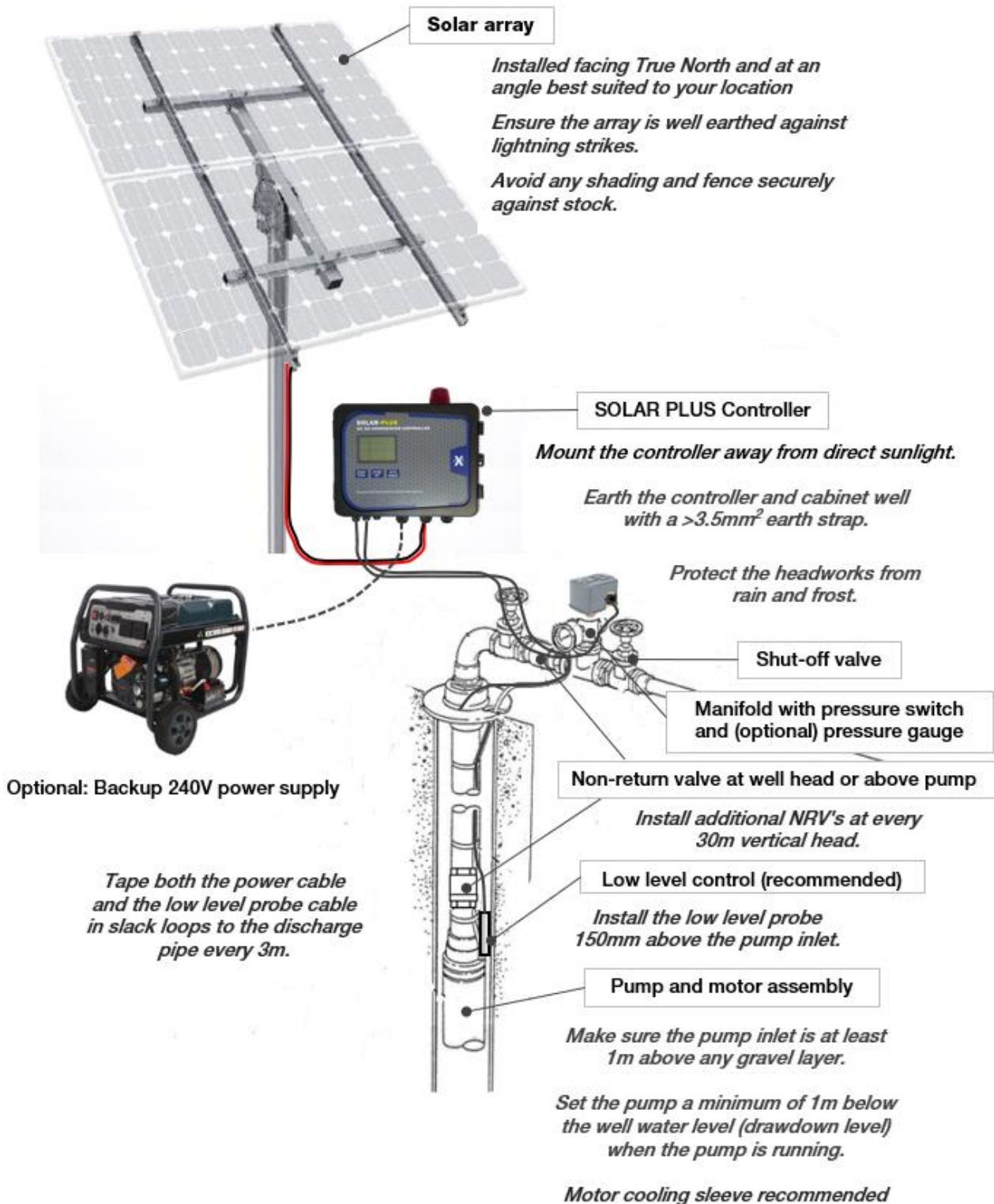

Never perform insulation resistance checks using a megohmmeter as this can damage the internal motor electronics.

SECTION FOUR: SOLAR ARRAY

The power supply from a DC power source such as solar panels can cause **SERIOUS HARM** or **DEATH** from electrocution



- Use appropriate safety procedures when working on any system component
- Only suitable qualified personnel should carry out electrical connection/disconnection
- Off-grid electrical equipment is subject to applicable regional and national electrical standards
- Always treat solar panels as **LIVE** and handle with care
- Use correctly rated electrical cable and connectors

Solar Panels and their mounting systems (where applicable) are supplied separately and with their own instructions for positioning and assembly.

Always connect the solar panels in series respecting the Max VOC and Max Amperage of the motor and controller Excessive voltage or current can cause serious harm or irreparable damage voiding warranty.

Power Source	Voltage	Current
DC Direct Current i.e. Solar	60 – 380Vmp 60 - 440Voc	12A DC (Isc)

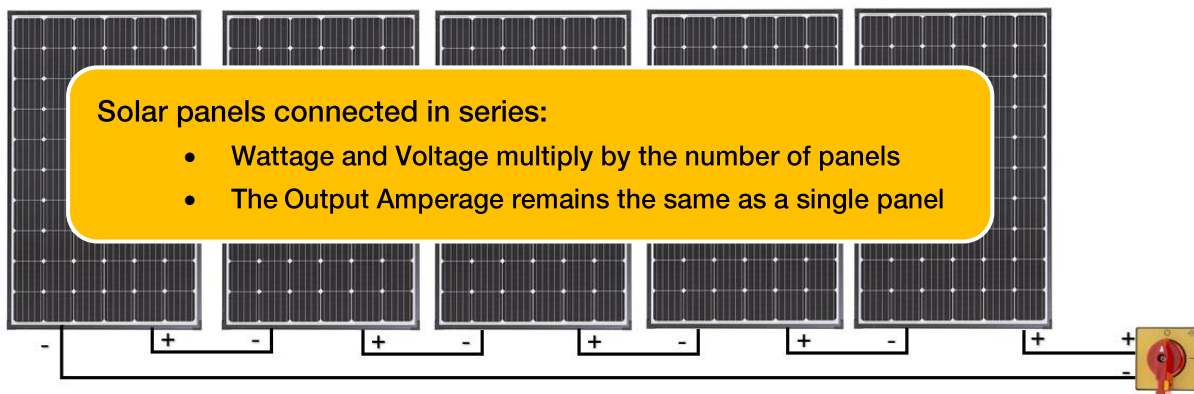

Example: 440W Solar panel			
51.8 Voc	4 panels:	$4 \times 440W = 1760W$	$4 \times 51.8 Voc = 362.6 Voc$
10.64 A Isc	Connected in series, Amperage remains the same		
44 Vmpp	7 panels:	$7 \times 440W = 3080W$	$7 \times 51.8 Voc = 201.2Voc$
10.01 A Impp	Connected in series, Amperage remains the same		

Adding more panels can effectively extend the length of the pumping day, however the pump output is constrained by the wet-end hydraulics and maximum pump motor rpm.

4a. Solar array installation

SOLAR ARRAY

- The Solar array must face True North.
- The solar panel angle should correspond to the latitude of the site. Consult the instructions supplied with the solar array to assist your decision regarding the best angle for your situation.

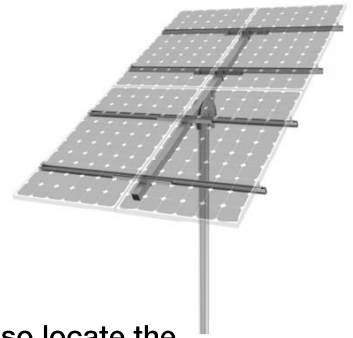

As a rule of thumb, solar panels should be more vertical during winter to gain most of the low winter sun, and flatter during summer to maximize the output.

- Protect the array and controller from stock.
- Any shading whatsoever will reduce the solar panel(s) performance so locate the panels with this in mind. Panel shadowing is like “open circuiting” a panel.
- Dust or bird droppings will impair the array energy output. Keep panels clean.
- Ensure the array is earthed to ground in the event of lightning strike.

To minimise energy losses the following chart provides recommended cable sizes.

White International recommend the installer perform their own calculations to satisfy themselves the cable sizing is correct, targeting a maximum voltage drop of 3%.

Solar Panel Input			Cable Length (Up to 'X' meters)									
DC Input Watts	Vmpp Volts	I _{mp} Amps	10	25	50	75	100	125	150	200	250	300
440	44	10	4	6								
880	88	10	2.5	6	6	10						
1320	132	10	1.5	4	6	10						
1760	176	10	1.5	2.5	6	10	10					
2200	220	10	1.5	2.5	4	6	10	10				
2640	264	10	1.5	2.5	4	6	6	10	10			
3080	308	10	1.5	1.5	4	4	6	10	10	10		
3520	352	10	1.5	1.5	2.5	4	6	10	10	10		

Losses less than 3%	1.5	4mm ² cross section cable	10mm ² cross section Up to 5% losses	
	2.5	6mm ² cross section cable		
	4	4mm ² cross section cable		
	6	6mm ² cross section cable		
	10	10mm ² cross section cable		
			Red box	Larger than 10mm ² required

ROOF MOUNT ARRAY (NZ Only):

Because the most common structure is a wooden frame, the panels and mounting system have no direct path to earth. In the event of lightning strike, the earth path is entirely via the combiner box.

- Install a minimum 6mm² earth strap to a ground stake.

GENERATOR SIZING:

Total kW of the solar array, (x 1.1 / 0.8) = minimum kVa required from the generator.

To achieve full output power output from a M240 motor, around 4kVa is recommended

SECTION FIVE: SYSTEM OPERATION

- Ensure all electrical connections are joined correctly and there are no bare wires.
- Ensure any output valves fitted to the system are open.
- Ensure that the pump is completely immersed,
- Check the DC input isolator is switched on.

The display screen will illuminate when there is energy available.

The display provides information related to the current state of the system

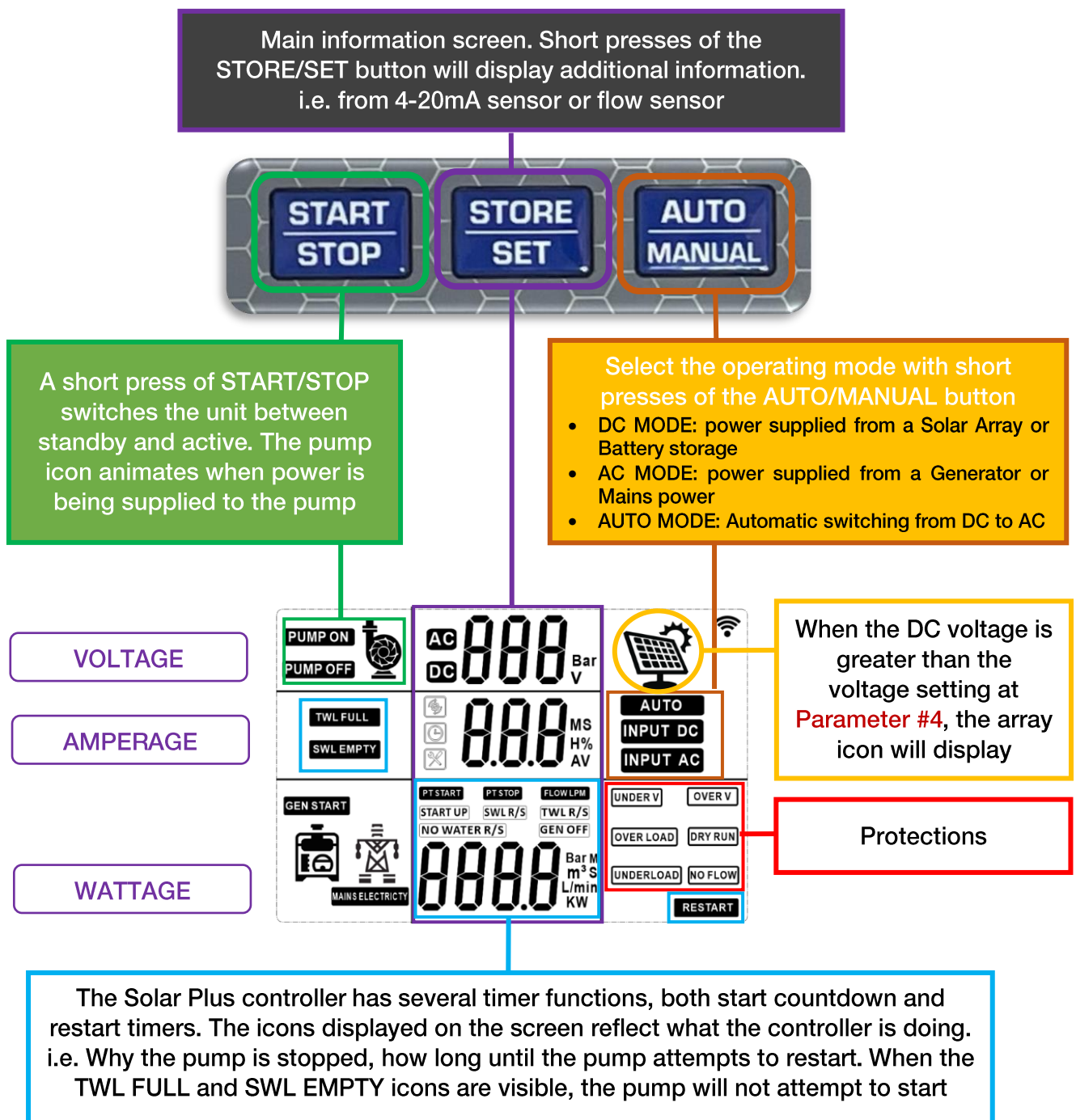

A

Select the mode of operation: Auto, AC or DC

The **AUTO**, **AC** or **DC** button will illuminate to indicate the selected power mode

In auto mode, the controller will select the power source to run the pump depending on input signals. Bias is always DC power source.

When the system is using AC power, the **INPUT AC** indicator button pulses

When the system is using DC power, the **INPUT DC** indicator button pulses

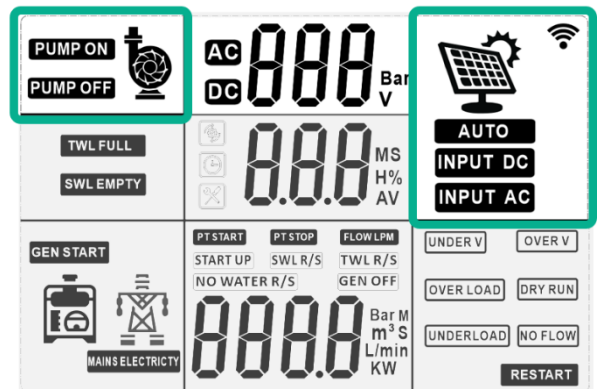

*Note – When switching between modes, the motor needs to dissipate the energy stored within the internal capacitors. This process takes (default) 2 minutes. The **RESTART** and **START UP** indicator buttons will display as will the countdown timer*

Repeated switching between modes restarts the dissipation cycle (restart countdown), causing extended delays before the pump will run.

B

Press START/STOP button to commence operation

The run state indicator will change from **PUMP OFF** to **PUMP ON**.

The controller will assess the available energy. If the minimum threshold is met the controller display will count down to dissipate any internal stored energy. This process cannot be sped up.

Once the motor starts, the display will indicate the energy the motor is consuming.

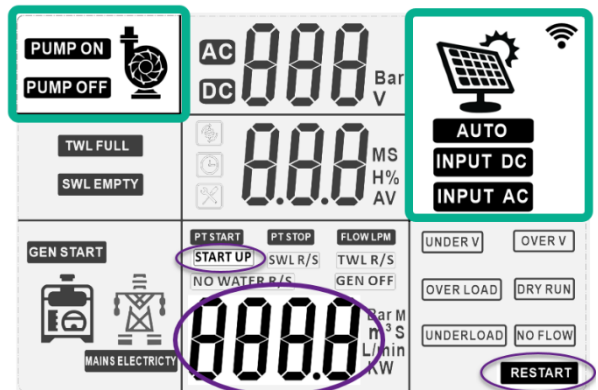

The internal electronics vary the pump running speed (and therefore flow output) depending on the energy available by employing MPPT and Vector control to achieve maximum efficiency.

Solar energy changes constantly especially on cloudy days. **The display values will be constantly changing as the pump adjusts to optimise the output based on the available input power.**

The display value indicates what the pump is currently consuming. It is NOT a measure of solar array output. The DC Voltage value and Amperage underneath provide information about the solar array performance.

It is normal that the values are constantly changing.

Commissioning note:

It is common when commissioning a new installation that the available solar irradiation is past the peak of the day or is compromised by cloudy or otherwise poor weather

Use a generator (4kVa) to check the installation. If the pump runs on AC power, it will run when DC power is available.

However, depending on the output of the generator vs the size of the array, the performance of the pump when connected to the generator may be greater than maximum available from the solar array.

If a pressure switch or pressure sensor is fitted to the discharge pipe it will be critical to ensure the pump can attain sufficient pressure when connected to the solar array.

E Should either of the switch circuits SWL EMPTY / TWL FULL activate they will stop the pump running and prevent it from restarting until the switched circuit state reverts.

The RESTART icon will display, and a countdown timer commence as per the delay set at **Parameters #15 / 16**. The icon related to the countdown will display so the user can clearly understand what is occurring

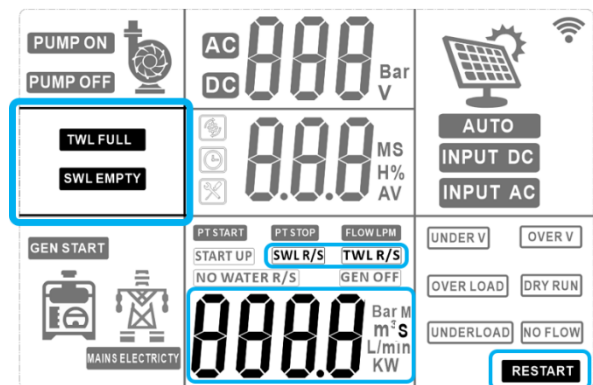

D With a 4-20mA pressure transducer input (dip-switch Position #2 ON, **Parameters #22 - 24** set correctly) the top middle display will cycle between voltage and pressure every 3 seconds

Once the pressure exceeds the upper stop set point the unit enters the TWL restart cycle. This cycle will repeat continuously until pressure falls below the start set point – **Parameter #24** allowing the pump to start again. The pressure reading has priority over the TWL circuit

E With a flow sensor attached (Dip Switch Pos #3 ON) the controller monitors the pulse rate from the flow sensor. The display will indicate flow rate. If the flow rate falls below the values set in **Parameters #11 - 13** the pump will shut down and enter a restart cycle (delay as per **Parameters #19 / 20**)

F Should the controller sense conditions outside **Parameters #04 – 08**, the pump will shut down and enter a recovery / restart cycle as per the delay set at **Parameters #17 / 18**.

G To suspend operation, press START/STOP. The PUMP OFF icon will display

SECTION SIX: TROUBLE SHOOTING

Isolate all electrical sources before commencing any installation, servicing, or repair on any component in the installation.

The SOLAR PLUS Controller is used to switch AC and DC power supplies and can automatically start a connected generator or switch between DC (Solar) or AC (Generator / Mains) power sources at ANY time.

Ensure all energy sources and generator starting circuit is properly locked-out before working on the system.



For the end-user, their expectation of how the pump should operate is often based on conventional electric pumping systems.

In normal operation the iSolar motor is an ever-changing device as it constantly adjusts itself to optimise the available power to maximise water delivery.

Every application is different, every power combination has an effect and environmental conditions change how the pump operates. On sunny windy days with clouds blowing by the pump operation can be positively erratic.

It may be that the 'strange behaviour' observed is simply the pump optimising the available energy.

The best indication that there is a problem is if the water delivered per day is dramatically less than normal.

Expect ½ as much water per day in the middle of winter as in summer. There is less solar energy available

Take the time to read the following information to gain an all-important understanding of how the pump and controller are intended to operate.

Each element of the system must be checked and eliminated as a possible cause.

- Solar array – consider available solar energy
- Wiring connections
- Controller
- Controller inputs (floats / switches / pressure sensor / flow sensor)
- Wiring from controller to pump
- Pump Motor
- Pump Wet-end
- System piping (leaks etc)

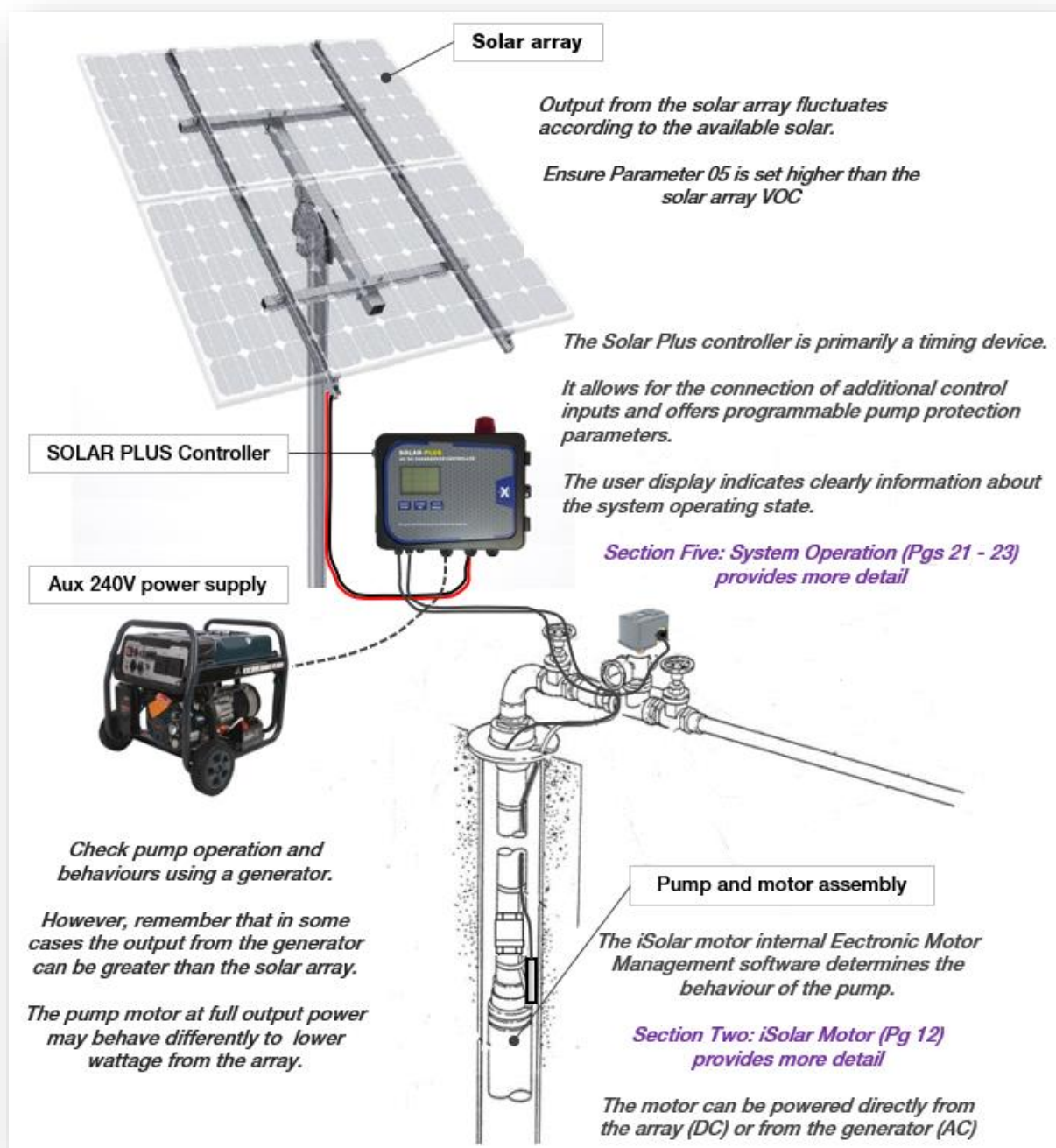

Motor Internal electronics

The electronics inside the motor monitor current, rpm and electrical load. They adjust the motor according to the input power available.

If there is insufficient power for the motor to reach its target speed range (1800 – 3600 rpm) then the motor will shut down and begin its start-up cycle again.

Just because ‘the sun is shining’ does not automatically guarantee there is sufficient solar energy for the pump to run, particularly early or late in the day.

If for example, the day is overcast, the pump may struggle to reach its optimum operating range. The motor may have sufficient voltage but the overall wattage is too low to run the motor at the necessary head so the motor will shut down and restart until the power is stable.

This same behaviour occurs if there is excessive start-up torque.

Iron contamination, silt in the water, degrading thrust bearing or simply insufficient solar output to start small flow / high pressure wet-ends can create issues

The motor does not know specifically why it is unable to run. Its internal programming is intended to protect the pump should it be unable to operate within its safe duty range.

External factors such as insufficient flow (water starvation, excessive head/torque, or other blockages) can also cause the motor to shut down so check entire system to ensure the issue is not related to valving or piping etc.

Motor not producing enough flow:

- Is the Pump completely submerged in operation (false dry run)?
- Is the water depleting too quickly?
- Ensure the pump inlet is clean and there is no clogging

Motor will not start:

- Check the AC/ DC undervoltage settings. There may not be sufficient energy available
- Does DC supply exceed maximum or minimum settings? **Check Parameters #04/05 (Max: 440VDC Voltage Open Circuit, Max Short circuit current 12A DC)**
- Does AC power exceed a maximum of 280V? **Check Parameters #06/07 (Max Short circuit current 10A AC)**

Check the panels for any damage or shading. Shade, bird droppings or dust on a single panel will compromise the output of the whole array.

Check pump operation by connecting a generator.

With a generator supplying maximum 240V 10A, the motor will run at its maximum output.

Note: A system which is undersized or requires excessive power compared to the design duty will sometimes deliver water on a generator but not on DC power.

If the motor is experiencing excessive load, it will reduce its power consumption and shut down. Ensure the pump inlet is clean and not blocked. Insufficient flow due to a blocked inlet or a blocked discharge can cause the pump to shut down.

Remove the motor from the wet-end. The motor shaft should have considerable resistance to rotation due to the internal magnetism of the motor.

A motor which can be rotated freely by hand (no resistance) has lost its magnetism and should be serviced or replaced.

SOLAR PLUS Controller

The controller does not directly influence the behaviour of the motor once it is running. Rather the controller monitors the power available from the solar array and adds a greater level of protection by allowing various control inputs

The controller display provides a visual indication as to what is happening as covered in the System Operation pages (Pgs 21 – 23)



- Check the display to ensure there is power at the controller.
- Check there is enough power at the controller (available Voltage and Amperage)
- Check for loose or poor DC voltage connections.
- Check that the controller is not applying a delay function.
- Check the inputs to the solar controller
 - To isolate the inputs - bridge the TWL (closed). Leave SWL open.
- The 4-20mA sensor or flow meter can be isolated by switching the appropriate dip switch position off.

To eliminate the SOLAR PLUS controller as a possible cause of any unusual behaviour, have a suitably qualified person connect the energy input from the solar array (DC) or from a 240V AC power source directly to the motor.

Flow meter

The flow sensor is a non-directional turbine wheel type. It generates pulses of voltage which the Solar Plus controller translates to a flow value.

Flow sensor manufacturing batch variations may require the black and red wire positions to be reversed to ensure the controller can read the flow signal.

Blow GENTLY through the sensor to mimic flow and check it is reading before installing

Parameters 11 and 12 are related and used determine the sensitivity of the reading

- Parameter 11 is the number of pulses
- Parameter 12 is the measurement time period

If during the time period (Parameter 12), there are less pulses than the value set at Parameter 11, a restart countdown will activate for the time period entered at Parameter 19

Parameter 13 allows for a number of no-flow restart attempts. If the no-flow restart attempts exceed the value set at Parameter 13, a secondary delay timer activates for the time period entered at Parameter 20.

Typically, Parameter 19 would be of shorter duration that Parameter 20

11	Minimum flow (pulses)	Range 0 – 254	Default 30
12	Trip Measurement period Related to Parameter #11	Range 0 – 254 sec	Default 180 sec
13	No flow restart attempts	Range 1 – 60	Default 05
14	Power on countdown timer	Range 1 – 254 sec	Default 120 sec
15	SWL restart delay timer	Range 0 – 60 min	Default 10 min
19	Flow recovery restart time	Range 00 – 60 min	Default 30 min
20	No flow (pulse) restart time	Range 00 – 60 min	Default 60 min

6a. Trouble shooting chart

Problem	Possible cause
Pump does not start	Fault on the TWL circuit WWL circuit open Control box in sun or near heat source (overheated) Low voltage supply to motor (low solar irradiation) Controller switching between energy sources
No water delivered	Low solar irradiation Water level too low in well Inlet clogged Broken pump shaft or coupling Check valve installed backwards Check valve stuck closed Hole in delivery pipe
Poor water delivery	Fittings stopping check valve opening fully Water level too low in well Discharge pipe clogged, corroded or ruptured Pump installed too low in well and covered with sand or other solids Inlet screen partially clogged Worn pump Leak in outlet pipe below top of bore Check valve stuck partially closed
Pump does not shut off	Pipe ruptured Defective or improperly adjusted pressure switch Water level too deep for pump. Check selection Pump is air or gas bound Worn pump Pipe obstruction
Electric shock from water pipe	Defective (grounded) incoming power leads Defective control box Earth wire connected to wrong control box terminal <i>Note: A motor down to earth or defective cable will not cause a shock.</i>

Warranty: To be inspected for warranty, the motor must be returned with cable and joint intact.

White International require the cable be cut at least 100mm above the cable joint.

If more assistance is required, contact White International

WARRANTY – Terms and Conditions

This warranty is given in addition to the consumer guarantees found within the Australian Competition and Consumer Act 2010 (Cth) for goods purchased in Australia and the Consumer Guarantees Act 1993 NZ for goods purchased in New Zealand:



- 1) White International Pty Ltd / White International NZ Ltd (White International) warrant that all products distributed are free from defects in workmanship and materials, for their provided warranty period as indicated on the top or opposite side of this document. Subject to the conditions of the warranty, White International will repair any defective products free of charge at the premises of our authorised service agents throughout Australia and New Zealand if a defect in the product appears during the warranty period. If you believe that you have purchased a defective product and wish to make a claim under this warranty, contact us on our Sales Hotline on 1300 783 601, or send your claim to our postal address or fax line below and we will advise you as to how next to proceed. You will be required to supply a copy of your proof of purchase to make a claim under this warranty.
- 2) This warranty excludes transportation costs to and from White International or its appointed service agents and excludes defects due to non-compliance with installation instructions, neglect or misuse, inadequate protection against the elements, low voltage or use or operation for purposes other than those for which they were designed. For further information regarding the suitability of your intended application contact us on our Sales Hotline on 1300 783 601. If you make an invalid claim under this warranty, the original product will be sent back to you unrepai red.
- 3) This warranty refers only to products sold after the 1st January 2012, and is not transferable to another product type and only applies to the original owner, purchaser or end user, and is in addition to the consumer guarantees found within the Competition and Consumer Act 2010 (Cth) for goods purchased in Australia and the Consumer Guarantees Act 1993 (NZ) for goods purchased in New Zealand.
- 4) Our goods come with guarantees that cannot be excluded under the Australian Consumer Law. You are entitled to a replacement or refund for a major failure and for compensation for any other reasonably foreseeable loss or damage. You are also entitled to have the goods repaired or replaced if the goods fail to be of acceptable quality and the failure does not amount to a major failure. 2 YEAR WARRANTY
- 5) To the fullest extent permitted by law, White International excludes its liability for all other conditions or warranties which would or might otherwise be implied at law. To the fullest extent permitted by law, White International's liability under this warranty and any other conditions, guarantees or warranties at law that cannot be excluded, including those in the Competition and Consumer Act 2010 (Cth), is expressly limited to: (a) in the case of products, the replacement of the product or the supply of equivalent product, the payment of the cost of replacing the product or of acquiring an equivalent product or the repair of the product or payment of the cost of having the product repaired, is at the discretion of White International or a 3rd party tribunal elected under the Competition and Consumer Act 2010 (Cth) for goods purchased in Australia and the Consumer Guarantees Act 1993 (NZ) for goods purchased in New Zealand; and
- 6) To the fullest extent permitted by law, this warranty supersedes all other warranties attached to the product or its packaging.
- 7) In the case of services, supplying the services again or the payment of the cost of having the services supplied again, is at the discretion of White International or a 3rd party tribunal elected under the Competition and Consumer Act 2010 (Cth) for goods purchased in Australia and the Consumer Guarantees Act 1993 (NZ) for goods purchased in New Zealand. 8) Our warranty commences from the date of purchase of the above-mentioned pumps. Proof of purchase is required before consideration under warranty is given.

Record your date of purchase in the space below and retain this copy for your records.

Date of Purchase**Model Purchased**



www.whiteint.com.au

1300 783 601

www.whiteint.co.nz

0800 509 506

Please always refer to our website for further technical information & new product innovations

Disclaimer: Every effort has been made to publish the correct information in this manual.

No responsibility will be taken for errors, omissions or changes in product specifications.

© 2024 Copyright White International Pty Ltd

TM ® - WARNING: Please be aware that various brands & products depicted within this document are subject to trademark, patent or design registrations. Infringement of any intellectual property contained within this document without express written authority by the appropriate intellectual property holder may result in further legal action to be taken. For any queries regarding use of the contained information please feel free to contact White International Pty Ltd.